



# NRC6791

## IEEE 802.11n Wi-Fi Solution + MCU SoC



### Overview

NRC6791 is a SoC, highly integrated IEEE 802.11n RF/Baseband/MAC solution operating in a single-stream mode for low-power standalones, embedded stations, access points, and Internet of Things (IoT) applications. NRC6791 supports both mandatory and optional features of the IEEE 802.11n standard and its corresponding Wi-Fi Alliance certifications. It can also be used in a variety of configurations, including IEEE 802.11b only and IEEE 802.11b/g or IEEE 802.11b/g/n combinations.

NRC6791 offers a complete and self-contained Wi-Fi networking solution by harnessing the capacity to host application or offload Wi-Fi networking functions from another application processor. NRC6791 is specially designed to achieve the lowest power consumption with a combination of several proprietary techniques for low-power mobile wearable electronics and IoT applications. NRC6791 also includes Wi-Fi Direct and Wi-Fi Aware peer-to-peer technologies, allowing great range of IoT usage, providing convenient and simple wireless connectivity, and enabling people to do more with their wireless products.



The RF is a complete radio front-end, optimized for IEEE 802.11b/g/n SoC implementation based on industry-proven direct conversion transceiver architecture. This transceiver IP has a fully integrated power amplifier and a CMOS RF switch. RF IO ports are single-ended and a fractional-N synthesizer while the power amplifier and PMU are fully integrated for minimum BOM and PIN counts.



### Target Applications

- o IoT applications
- o Wearables
- o Home automation
- o Healthcare
- o Industrial automation
- o Safety and security
- o Smart grid
- o Multimedia streaming

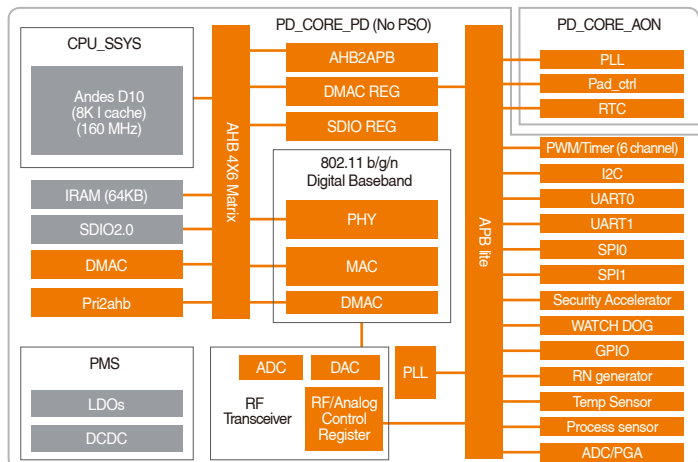



## Specification

### WLAN Technology: 802.11b/g/n

- 2.4 GHz Band
- 20/40 MHz channel bandwidth

### CPU

- Andes D10 with KB Cache

### Memory

- 48KB Boot ROM
- 304KB System SRAM
- XIP with cache (2 ways, 32KB)

### Communication Peripherals

- GPIOs/SPI/SDIO

- Power source: 3.3 V
- Package Type: 5 x 5 mm 32-pin QFN
- Operating Temperature: -40 to 85 oC

### Modem

- Modulation: BPSK, QPSK, 16QAM, 64QAM
- Data rate: 1 to 72.2 Mbps
- Support Traveling Pilot
- Power save mode (Legacy/WMM-PS, TWT)
- Security : AES-CCMP, IEEE 802.11w

### Dynamic range

- Max. output power +15 dBm (MCS7)
- TX gain range: 30 dB, 1 dB step
- RX sensitivity: - 109 dBm (11b)
- Max. input level: -10 dBm



## Key Features

- Fully integrated solution
  - RF CMOS switch
  - RF transceiver including LNA and PA
  - DC-DC buck converter
- Supports IEEE 802.11 b/g/n standard
  - 2.4 GHz ISM band
  - 20/40 MHz channel BW
- Supports WFA Wi-Fi Direct, Wi-Fi Aware, PMF and WPS
- Power saving with Legacy and WMM-PS
- Integrated low power 32-bit MCU
- Integrated TCP/IP protocol stack
- Supports STA/AP/STA+AP operation modes